

ACME-SHOREY

PRECAST CONCRETE PRODUCTS

NOTES:

- 1.) **LIMESTONE FACE**
- 2.) MAX HEIGHT OF STD GRAVITY WALLS APPROX 12'.
(USE GEOGRID FOR HIGHER HEIGHTS).
- 3.) USE 6" CAP BLOCK FOR FLAT TOP REQUIREMENTS
(INSTEAD OF CAP BOULDERS)
- 4.) OPTIONAL : TOP RAIL
- 5.) CURVED WALL DESIGN CAPABLE
DUE TO ANGLED BLOCK DESIGN.
- 6.) COMPLETE DESIGN SPECIFICATIONS:
[HTTPS://WWW.LONDONBOULDER.COM/](https://www.londonboulder.com/)

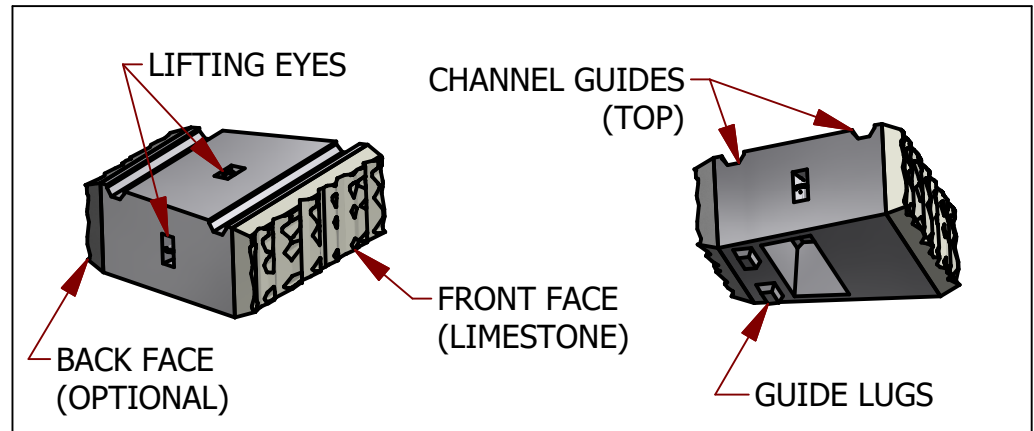
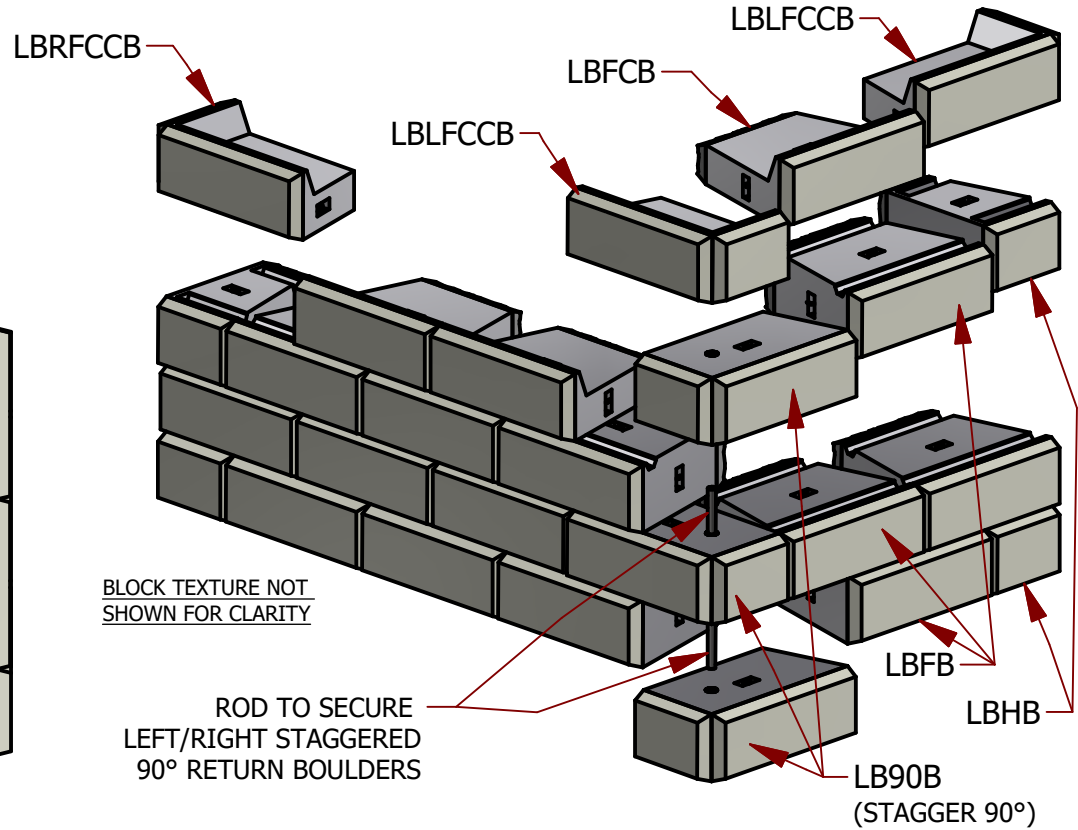
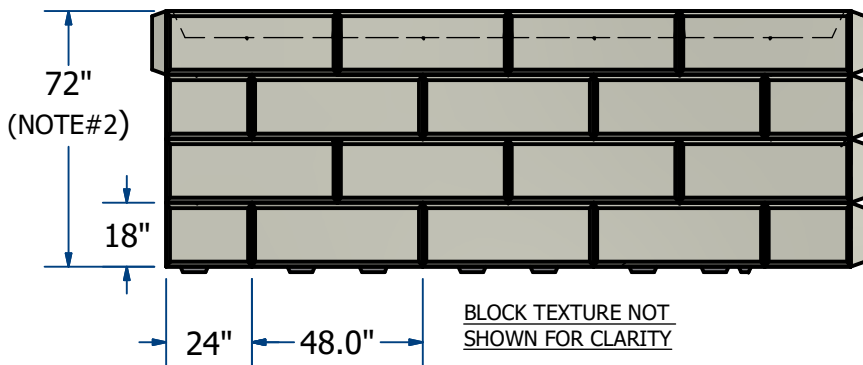
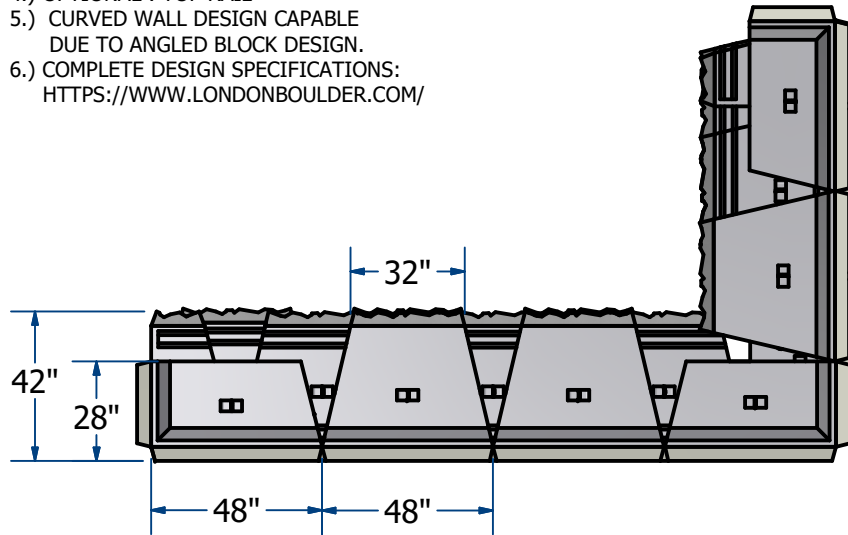

NAME: LONDON BOULDER LB42 ,WALL EXAMPLE

ITEM# LB42_WALL

CONCRETE MINIMUM STRENGTH: 5,000 p.s.i. AT 28 DAYS
 STEEL REINFORCEMENT: ASTM - A-615 - 68, GRADE 60
 DESIGN LOADING: STANDARD UNITS: AASHTO-H20

TEXTURE: LIMESTONE FACE

C

DATE: 2-15-21

ACME-SHOREY

PRECAST CONCRETE PRODUCTS

WWW.ACMESHOREY.COM

PHONE (508) 548-9607

FAX (508) 548-1664

CARVER, MA 02330
334 TREMONT STREET

HARWICH
36 GREAT WESTERN ROAD

| Sct 20 | ITEM # | London Boulder LB42 Size | Height | Size | Depth | Face Area | Wt. Ea. | | |
|----------|---------|-------------------------------|---------|-----------|-----------|-----------|---------|-----|------|
| Sct. | Item # | Big Block Type | Ht.(in) | Wdth (in) | Dpth (in) | Sqft | Lbs | Qty | Cost |
| 20 - 1.1 | LBFB | Full Boulder | 18 | 48 | 42 | 6 | 2425 | | |
| 20 - 1.2 | LBHB | Half Boulder | 18 | 24 | 42 | 3 | 1250 | | |
| 20 - 1.3 | LBFCB | Full Cap Boulder | 18 | 48 | 42 | 6 | 1700 | | |
| 20 - 1.4 | LBLFCCB | Left Full Cap Corner Boulder | 18 | 48 | 24 | 9 | 1525 | | |
| 20 - 1.5 | LBRFCCB | Right Full Cap Corner Boulder | 18 | 48 | 24 | 9 | 1525 | | |
| 20 - 1.6 | LB90B | 90 Degree Return Boulder | 18 | 48 | 24 | 9 | 2075 | | |
| 20 - 1.7 | LB6CB | 6" Cap Block | 6 | 40 | 34 | 3 | 740 | | |

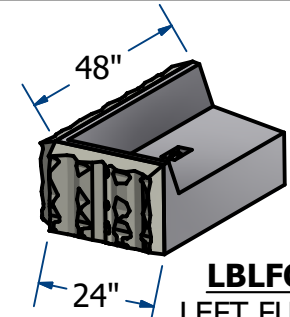

LBLFCCB
LEFT FULL CAP
CORNER BOULDER

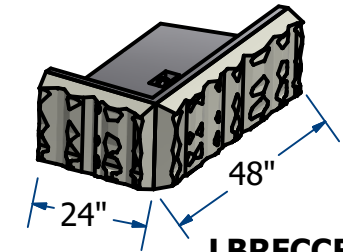

LBRFCCB
RIGHT FULL CAP
CORNER BOULDER

NOTES:
1.) LIMESTONE FACE

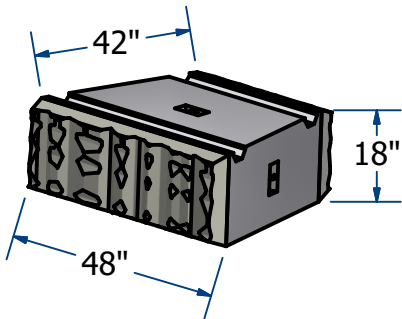

LBFB: FULL BOULDER

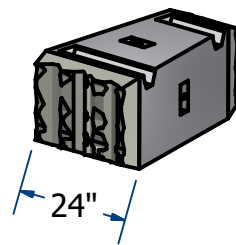

LBHB: HALF BOULDER

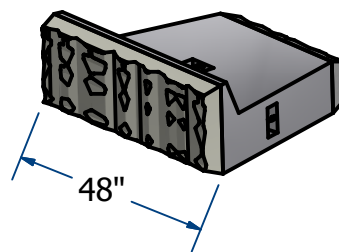

**LBFCB: FULL
CAP BOULDER**

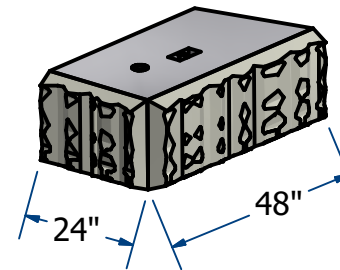

**LB90B: 90 DEGREE
RETURN BOULDER**

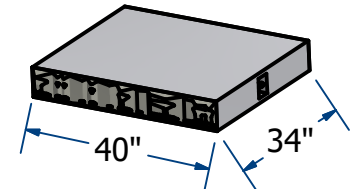

LB6CB: 6" CAP BLOCK

LB42 LONDON BOULDER WALL COMPONENTS

ITEM# LB42

DATE: 2-11-2021

20 - 1.1-1.7

Sht 2 of 2

Contractor: '

Project # :'

Location: '

JobName:'